

SN74HC193-Q1

4-BIT SYNCHRONOUS UP/DOWN COUNTER (DUAL CLOCK WITH CLEAR)

SCLS594A – NOVEMBER 2004 – REVISED APRIL 2008

- Qualified for Automotive Applications
- Wide Operating Voltage Range of 2 V to 6 V
- Outputs Can Drive Up To 10 LSTTL Loads
- Low Power Consumption, 80- μ A Max I_{CC}
- Typical $t_{pd} = 20$ ns
- ± 4 -mA Output Drive at 5 V
- Low Input Current of 1 μ A Max
- Look-Ahead Circuitry Enhances Cascaded Counters
- Fully Synchronous in Count Modes
- Parallel Asynchronous Load for Modulo-N Count Lengths
- Asynchronous Clear

description/ordering information

The SN74HC193 device is a 4-bit synchronous, reversible, up/down binary counter. Synchronous operation is provided by having all flip-flops clocked simultaneously so that the outputs change simultaneously with each other when dictated by the steering logic. This mode of operation eliminates the output counting spikes normally associated with asynchronous (ripple-clock) counters.

The outputs of the four flip-flops are triggered on a low-to-high-level transition of either count (clock) input (UP or DOWN). The direction of counting is determined by which count input is pulsed while the other count input is high.

All four counters are fully programmable; that is, each output may be preset to either level by placing a low on the load (\overline{LOAD}) input and entering the desired data at the data inputs. The output changes to agree with the data inputs independently of the count pulses. This feature allows the counters to be used as modulo-N dividers simply by modifying the count length with the preset inputs.

A clear (CLR) input has been provided that forces all outputs to the low level when a high level is applied. The clear function is independent of the count and \overline{LOAD} inputs.

This counter was designed to be cascaded without the need for external circuitry. The borrow (\overline{BO}) output produces a low-level pulse while the count is zero (all outputs low) and DOWN is low. Similarly, the carry (\overline{CO}) output produces a low-level pulse while the count is maximum (9 or 15), and UP is low. The counter then can be cascaded easily by feeding \overline{BO} and \overline{CO} to DOWN and UP, respectively, of the succeeding counter.

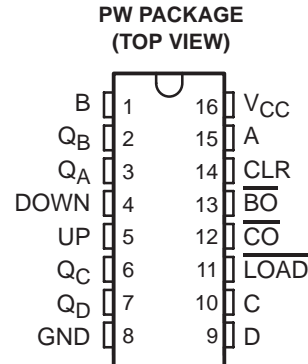

ORDERING INFORMATION[†]

T _A	PACKAGE [‡]	ORDERABLE PART NUMBER	TOP-SIDE MARKING
-40°C to 125°C	TSSOP – PW	Reel of 2000	SN74HC193QPWRQ1 HC193Q
-40°C to 85°C	TSSOP – PW	Reel of 2000	SN74HC193IPWRQ1 HC193I

[†] For the most current package and ordering information, see the Package Option Addendum at the end of this document, or see the TI web site at <http://www.ti.com>.

[‡] Package drawings, thermal data, and symbolization are available at <http://www.ti.com/packaging>.



Please be aware that an important notice concerning availability, standard warranty, and use in critical applications of Texas Instruments semiconductor products and disclaimers thereto appears at the end of this data sheet.

PRODUCTION DATA information is current as of publication date. Products conform to specifications per the terms of Texas Instruments standard warranty. Production processing does not necessarily include testing of all parameters.

**TEXAS
INSTRUMENTS**

POST OFFICE BOX 655303 • DALLAS, TEXAS 75265

Copyright © 2008, Texas Instruments Incorporated

SN74HC193-Q1
4-BIT SYNCHRONOUS UP/DOWN COUNTER
(DUAL CLOCK WITH CLEAR)

SCLS594A – NOVEMBER 2004 – REVISED APRIL 2008

logic diagram (positive logic)

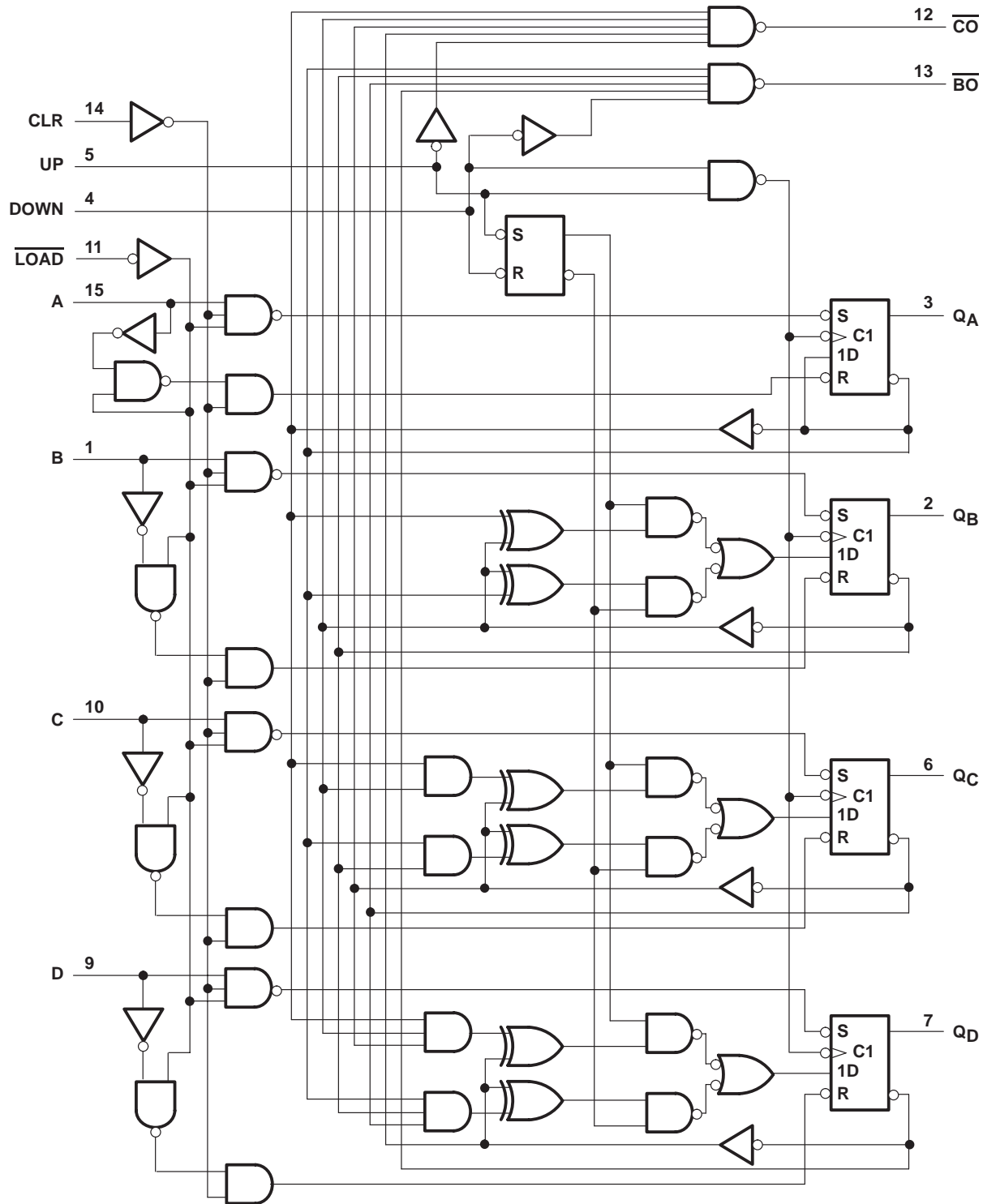

SN74HC193-Q1
4-BIT SYNCHRONOUS UP/DOWN COUNTER
(DUAL CLOCK WITH CLEAR)

SCLS594A – NOVEMBER 2004 – REVISED APRIL 2008

typical clear, load, and count sequence

The following sequence is illustrated below:

1. Clear outputs to 0
2. Load (preset) to binary 13
3. Count up to 14, 15, carry 0, 1, and 2
4. Count down to 1, 0, borrow 15, 14, and 13

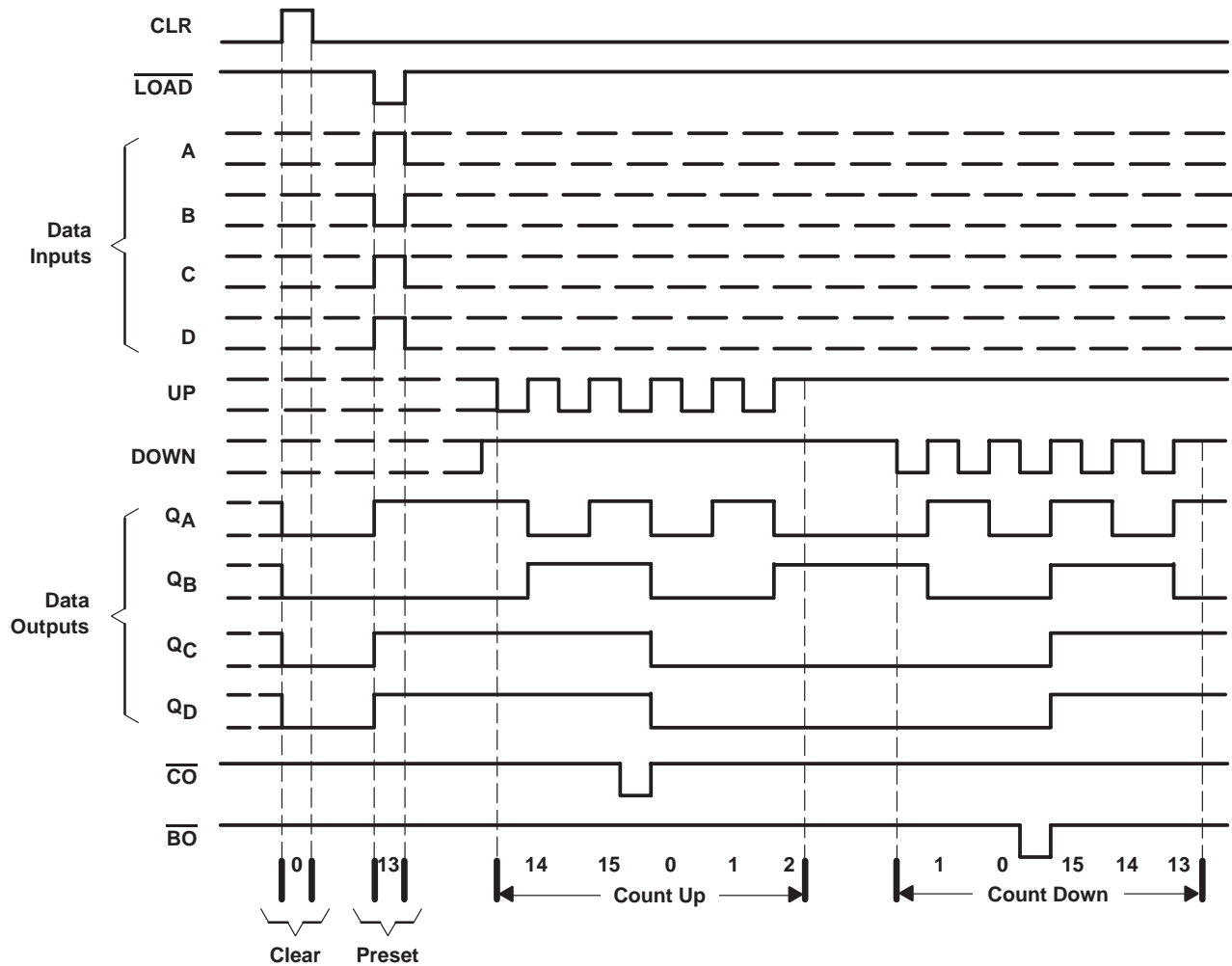

- NOTES: A. CLR overrides $\overline{\text{LOAD}}$, data, and count inputs.
 B. When counting up, count-down input must be high; when counting down, count-up input must be high.

SN74HC193-Q1

4-BIT SYNCHRONOUS UP/DOWN COUNTER (DUAL CLOCK WITH CLEAR)

SCLS594A – NOVEMBER 2004 – REVISED APRIL 2008

absolute maximum ratings over operating free-air temperature range (unless otherwise noted)[†]

Supply voltage range, V_{CC}	-0.5 V to 7 V
Input clamp current, I_{IK} ($V_I < 0$ or $V_I > V_{CC}$) (see Note 1)	± 20 mA
Output clamp current, I_{OK} ($V_O < 0$ or $V_O > V_{CC}$) (see Note 1)	± 20 mA
Continuous output current, I_O ($V_O = 0$ to V_{CC})	± 25 mA
Continuous current through V_{CC} or GND	± 50 mA
Package thermal impedance, θ_{JA} (see Note 2)	108°C/W
Storage temperature range, T_{stg}	-65°C to 150°C

[†] Stresses beyond those listed under “absolute maximum ratings” may cause permanent damage to the device. These are stress ratings only, and functional operation of the device at these or any other conditions beyond those indicated under “recommended operating conditions” is not implied. Exposure to absolute-maximum-rated conditions for extended periods may affect device reliability.

- NOTES: 1. The input and output voltage ratings may be exceeded if the input and output current ratings are observed.
2. The package thermal impedance is calculated in accordance with JESD 51-7.

recommended operating conditions (see Note 3)

		MIN	NOM	MAX	UNIT
V_{CC}	Supply voltage	2	5	6	V
V_{IH}	High-level input voltage	$V_{CC} = 2$ V	1.5		V
		$V_{CC} = 4.5$ V	3.15		
		$V_{CC} = 6$ V	4.2		
V_{IL}	Low-level input voltage	$V_{CC} = 2$ V		0.5	V
		$V_{CC} = 4.5$ V		1.35	
		$V_{CC} = 6$ V		1.8	
V_I	Input voltage	0		V_{CC}	V
V_O	Output voltage	0		V_{CC}	V
$\Delta t/\Delta v^\ddagger$	Input transition rise/fall time	$V_{CC} = 2$ V		1000	ns
		$V_{CC} = 4.5$ V		500	
		$V_{CC} = 6$ V		400	
T_A	Operating free-air temperature	Q-suffix devices	-40	125	°C
		I-suffix devices	-40	85	

NOTE 3: All unused inputs of the device must be held at V_{CC} or GND to ensure proper device operation. Refer to the TI application report, *Implications of Slow or Floating CMOS Inputs*, literature number SCBA004.

[‡] If this device is used in the threshold region (from $V_{ILmax} = 0.5$ V to $V_{IHmin} = 1.5$ V), there is a potential to go into the wrong state from induced grounding, causing double clocking. Operating with the inputs at $t_t = 1000$ ns and $V_{CC} = 2$ V does not damage the device; however, functionally, the CLK inputs are not ensured while in the shift, count, or toggle operating modes.



SN74HC193-Q1
4-BIT SYNCHRONOUS UP/DOWN COUNTER
(DUAL CLOCK WITH CLEAR)

SCLS594A – NOVEMBER 2004 – REVISED APRIL 2008

electrical characteristics over recommended operating free-air temperature range (unless otherwise noted)

PARAMETER	TEST CONDITIONS		V _{CC}	T _A = 25°C			T _A = -40°C TO 125°C		T _A = -40°C TO 85°C		UNIT
				MIN	TYP	MAX	MIN	MAX	MIN	MAX	
V _{OH}	V _I = V _{IH} or V _{IL}	I _{OH} = -20 μA	2 V	1.9	1.998		1.9		1.9	V	
			4.5 V	4.4	4.499		4.4		4.4		
			6 V	5.9	5.999		5.9		5.9		
		I _{OH} = -4 mA	4.5 V	3.98	4.3		3.7		3.84		
		I _{OH} = -5.2 mA	6 V	5.48	5.8		5.2		5.34		
V _{OL}	V _I = V _{IH} or V _{IL}	I _{OL} = 20 μA	2 V		0.002	0.1		0.1		0.1	V
			4.5 V		0.001	0.1		0.1		0.1	
			6 V		0.001	0.1		0.1		0.1	
		I _{OL} = 4 mA	4.5 V		0.17	0.26		0.4		0.33	
		I _{OL} = 5.2 mA	6 V		0.15	0.26		0.4		0.33	
I _I	V _I = V _{CC} or 0		6 V		±0.1	±100		±1000		±1000	nA
I _{CC}	V _I = V _{CC} or 0, I _O = 0		6 V			8		160		80	μA
C _i			2 V to 6 V		3	10		10		10	pF

SN74HC193-Q1
4-BIT SYNCHRONOUS UP/DOWN COUNTER
(DUAL CLOCK WITH CLEAR)

SCLS594A – NOVEMBER 2004 – REVISED APRIL 2008

timing requirements over recommended operating free-air temperature range (unless otherwise noted)

		V _{CC}	T _A = 25°C		T _A = -40°C TO 125°C		T _A = -40°C TO 85°C		UNIT
			MIN	MAX	MIN	MAX	MIN	MAX	
f _{clock}	Clock frequency	2 V	4.2		2.8		3.3		MHz
		4.5 V	21		14		17		
		6 V	24		16		19		
t _w	CLR high	2 V	120		180		150		ns
		4.5 V	24		36		30		
		6 V	21		31		26		
	LOAD low	2 V	120		180		150		
		4.5 V	24		36		30		
		6 V	21		31		26		
	UP or DOWN, high or low	2 V	120		180		150		
		4.5 V	24		36		30		
		6 V	21		31		26		
t _{su}	Data before LOAD inactive	2 V	110		165		140		ns
		4.5 V	22		33		28		
		6 V	19		28		24		
	CLR inactive before UP↑ or DOWN↓	2 V	110		165		140		
		4.5 V	22		33		28		
		6 V	19		28		24		
	LOAD inactive before UP↑ or DOWN↓	2 V	110		165		140		
		4.5 V	22		33		28		
		6 V	19		28		24		
t _h	Data after LOAD inactive	2 V	5		5		5		ns
		4.5 V	5		5		5		
		6 V	5		5		5		



SN74HC193-Q1
4-BIT SYNCHRONOUS UP/DOWN COUNTER
(DUAL CLOCK WITH CLEAR)

SCLS594A – NOVEMBER 2004 – REVISED APRIL 2008

switching characteristics over recommended operating free-air temperature range, $C_L = 50$ pF (unless otherwise noted) (see Figure 1)

PARAMETER	FROM (INPUT)	TO (OUTPUT)	V_{CC}	$T_A = 25^\circ\text{C}$			$T_A = -40^\circ\text{C TO } 125^\circ\text{C}$		$T_A = -40^\circ\text{C TO } 85^\circ\text{C}$		UNIT
				MIN	TYP	MAX	MIN	MAX	MIN	MAX	
f_{max}			2 V	4.2	8		2.8		3.3	MHz	
			4.5 V	21	55		14		17		
			6 V	24	60		16		19		
t_{pd}	UP	\overline{CO}	2 V		75	165		250		205	ns
			4.5 V		24	33		50		41	
			6 V		20	28		43		35	
	DOWN	\overline{BO}	2 V		75	165		250		205	
			4.5 V		24	33		50		41	
			6 V		20	28		43		35	
	UP or DOWN	Any Q	2 V		190	250		375		315	
			4.5 V		40	50		75		63	
			6 V		35	43		64		54	
			2 V		190	260		390		325	
			4.5 V		40	52		78		65	
			6 V		35	44		66		55	
t_{PHL}	CLR	Any Q	2 V		170	240		360		300	ns
			4.5 V		36	48		72		60	
			6 V		31	41		61		51	
t_t		Any	2 V		38	75		110		95	ns
			4.5 V		8	15		22		19	
			6 V		6	14		19		17	

operating characteristics, $T_A = 25^\circ\text{C}$

PARAMETER	TEST CONDITIONS	TYP	UNIT
C_{pd} Power dissipation capacitance	No load	50	pF

SN74HC193-Q1
4-BIT SYNCHRONOUS UP/DOWN COUNTER
(DUAL CLOCK WITH CLEAR)

SCLS594A – NOVEMBER 2004 – REVISED APRIL 2008

PARAMETER MEASUREMENT INFORMATION

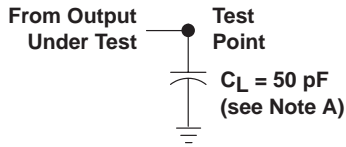

LOAD CIRCUIT

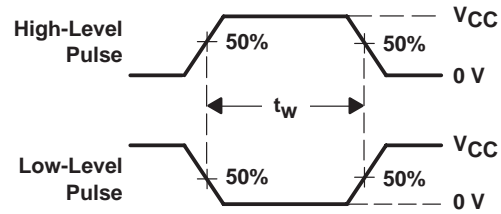

VOLTAGE WAVEFORMS
PULSE DURATIONS

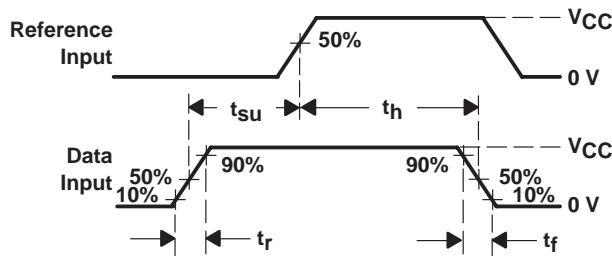

VOLTAGE WAVEFORMS
SETUP AND HOLD AND INPUT RISE AND FALL TIMES

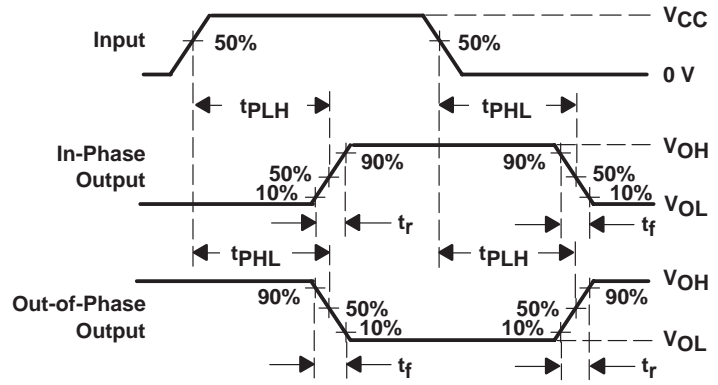

VOLTAGE WAVEFORMS
PROPAGATION DELAY AND OUTPUT TRANSITION TIMES

- NOTES:
- A. C_L includes probe and test-fixture capacitance.
 - B. Phase relationships between waveforms were chosen arbitrarily. All input pulses are supplied by generators having the following characteristics: $PRR \leq 1 \text{ MHz}$, $Z_O = 50 \Omega$, $t_r = 6 \text{ ns}$, $t_f = 6 \text{ ns}$.
 - C. For clock inputs, f_{max} is measured when the input duty cycle is 50%.
 - D. The outputs are measured one at a time, with one input transition per measurement.
 - E. t_{PLH} and t_{PHL} are the same as t_{pd} .

Figure 1. Load Circuit and Voltage Waveforms

PACKAGING INFORMATION

Orderable Device	Status ⁽¹⁾	Package Type	Package Drawing	Pins	Package Qty	Eco Plan ⁽²⁾	Lead/Ball Finish	MSL Peak Temp ⁽³⁾
SN74HC193QPWRG4Q1	ACTIVE	TSSOP	PW	16	2000	Green (RoHS & no Sb/Br)	CU NIPDAU	Level-1-260C-UNLIM
SN74HC193QPWRQ1	ACTIVE	TSSOP	PW	16	2000	Pb-Free (RoHS)	CU NIPDAU	Level-1-250C-UNLIM

⁽¹⁾ The marketing status values are defined as follows:

ACTIVE: Product device recommended for new designs.

LIFEBUY: TI has announced that the device will be discontinued, and a lifetime-buy period is in effect.

NRND: Not recommended for new designs. Device is in production to support existing customers, but TI does not recommend using this part in a new design.

PREVIEW: Device has been announced but is not in production. Samples may or may not be available.

OBsolete: TI has discontinued the production of the device.

⁽²⁾ Eco Plan - The planned eco-friendly classification: Pb-Free (RoHS), Pb-Free (RoHS Exempt), or Green (RoHS & no Sb/Br) - please check <http://www.ti.com/productcontent> for the latest availability information and additional product content details.

TBD: The Pb-Free/Green conversion plan has not been defined.

Pb-Free (RoHS): TI's terms "Lead-Free" or "Pb-Free" mean semiconductor products that are compatible with the current RoHS requirements for all 6 substances, including the requirement that lead not exceed 0.1% by weight in homogeneous materials. Where designed to be soldered at high temperatures, TI Pb-Free products are suitable for use in specified lead-free processes.

Pb-Free (RoHS Exempt): This component has a RoHS exemption for either 1) lead-based flip-chip solder bumps used between the die and package, or 2) lead-based die adhesive used between the die and leadframe. The component is otherwise considered Pb-Free (RoHS compatible) as defined above.

Green (RoHS & no Sb/Br): TI defines "Green" to mean Pb-Free (RoHS compatible), and free of Bromine (Br) and Antimony (Sb) based flame retardants (Br or Sb do not exceed 0.1% by weight in homogeneous material)

⁽³⁾ MSL, Peak Temp. -- The Moisture Sensitivity Level rating according to the JEDEC industry standard classifications, and peak solder temperature.

Important Information and Disclaimer:The information provided on this page represents TI's knowledge and belief as of the date that it is provided. TI bases its knowledge and belief on information provided by third parties, and makes no representation or warranty as to the accuracy of such information. Efforts are underway to better integrate information from third parties. TI has taken and continues to take reasonable steps to provide representative and accurate information but may not have conducted destructive testing or chemical analysis on incoming materials and chemicals. TI and TI suppliers consider certain information to be proprietary, and thus CAS numbers and other limited information may not be available for release.

In no event shall TI's liability arising out of such information exceed the total purchase price of the TI part(s) at issue in this document sold by TI to Customer on an annual basis.

OTHER QUALIFIED VERSIONS OF SN74HC193-Q1 :

- Catalog: [SN74HC193](#)
- Military: [SN54HC193](#)

NOTE: Qualified Version Definitions:

- Catalog - TI's standard catalog product
- Military - QML certified for Military and Defense Applications

PW (R-PDSO-G**)

PLASTIC SMALL-OUTLINE PACKAGE

14 PINS SHOWN



4040064/F 01/97

- NOTES: A. All linear dimensions are in millimeters.
 B. This drawing is subject to change without notice.
 C. Body dimensions do not include mold flash or protrusion not to exceed 0,15.
 D. Falls within JEDEC MO-153

IMPORTANT NOTICE

Texas Instruments Incorporated and its subsidiaries (TI) reserve the right to make corrections, modifications, enhancements, improvements, and other changes to its products and services at any time and to discontinue any product or service without notice. Customers should obtain the latest relevant information before placing orders and should verify that such information is current and complete. All products are sold subject to TI's terms and conditions of sale supplied at the time of order acknowledgment.

TI warrants performance of its hardware products to the specifications applicable at the time of sale in accordance with TI's standard warranty. Testing and other quality control techniques are used to the extent TI deems necessary to support this warranty. Except where mandated by government requirements, testing of all parameters of each product is not necessarily performed.

TI assumes no liability for applications assistance or customer product design. Customers are responsible for their products and applications using TI components. To minimize the risks associated with customer products and applications, customers should provide adequate design and operating safeguards.

TI does not warrant or represent that any license, either express or implied, is granted under any TI patent right, copyright, mask work right, or other TI intellectual property right relating to any combination, machine, or process in which TI products or services are used. Information published by TI regarding third-party products or services does not constitute a license from TI to use such products or services or a warranty or endorsement thereof. Use of such information may require a license from a third party under the patents or other intellectual property of the third party, or a license from TI under the patents or other intellectual property of TI.

Reproduction of TI information in TI data books or data sheets is permissible only if reproduction is without alteration and is accompanied by all associated warranties, conditions, limitations, and notices. Reproduction of this information with alteration is an unfair and deceptive business practice. TI is not responsible or liable for such altered documentation. Information of third parties may be subject to additional restrictions.

Resale of TI products or services with statements different from or beyond the parameters stated by TI for that product or service voids all express and any implied warranties for the associated TI product or service and is an unfair and deceptive business practice. TI is not responsible or liable for any such statements.

TI products are not authorized for use in safety-critical applications (such as life support) where a failure of the TI product would reasonably be expected to cause severe personal injury or death, unless officers of the parties have executed an agreement specifically governing such use. Buyers represent that they have all necessary expertise in the safety and regulatory ramifications of their applications, and acknowledge and agree that they are solely responsible for all legal, regulatory and safety-related requirements concerning their products and any use of TI products in such safety-critical applications, notwithstanding any applications-related information or support that may be provided by TI. Further, Buyers must fully indemnify TI and its representatives against any damages arising out of the use of TI products in such safety-critical applications.

TI products are neither designed nor intended for use in military/aerospace applications or environments unless the TI products are specifically designated by TI as military-grade or "enhanced plastic." Only products designated by TI as military-grade meet military specifications. Buyers acknowledge and agree that any such use of TI products which TI has not designated as military-grade is solely at the Buyer's risk, and that they are solely responsible for compliance with all legal and regulatory requirements in connection with such use.

TI products are neither designed nor intended for use in automotive applications or environments unless the specific TI products are designated by TI as compliant with ISO/TS 16949 requirements. Buyers acknowledge and agree that, if they use any non-designated products in automotive applications, TI will not be responsible for any failure to meet such requirements.

Following are URLs where you can obtain information on other Texas Instruments products and application solutions:

Products

Amplifiers	amplifier.ti.com
Data Converters	dataconverter.ti.com
DSP	dsp.ti.com
Clocks and Timers	www.ti.com/clocks
Interface	interface.ti.com
Logic	logic.ti.com
Power Mgmt	power.ti.com
Microcontrollers	microcontroller.ti.com
RFID	www.ti-rfid.com
RF/IF and ZigBee® Solutions	www.ti.com/lprf

Applications

Audio	www.ti.com/audio
Automotive	www.ti.com/automotive
Broadband	www.ti.com/broadband
Digital Control	www.ti.com/digitalcontrol
Medical	www.ti.com/medical
Military	www.ti.com/military
Optical Networking	www.ti.com/opticalnetwork
Security	www.ti.com/security
Telephony	www.ti.com/telephony
Video & Imaging	www.ti.com/video
Wireless	www.ti.com/wireless

Mailing Address: Texas Instruments, Post Office Box 655303, Dallas, Texas 75265
Copyright © 2008, Texas Instruments Incorporated